

## 1300 nm Laser in Coaxial Package with SM-Pigtail, Low Power

STL 51004X  
STL 51005X

- Designed for application in fiber-optic networks
- Laser diode with Multi-Quantum Well structure
- Suitable for bit rates up to 1 Gbit/s
- Ternary photodiode at rear mirror for monitoring and control of radiant power
- Hermetically sealed subcomponent, similar to TO 18
- SM Pigtail with optional flange

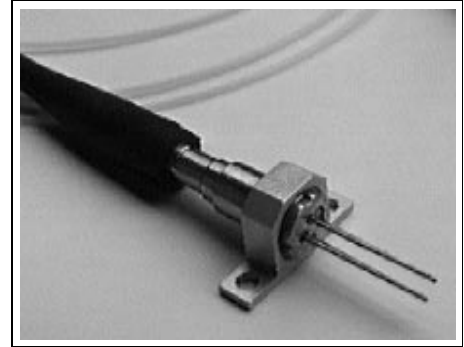

Type	Ordering Code	Connector/Flange
STL 51004G	Q62702-P3058	FC / without flange
STL 51004A	Q62702-P3057	DIN / without flange
STL 51005G	Q62702-P3055	FC / with flange
STL 51005A	Q62702-P3054	DIN / with flange

**Component with other connector types on request.**

### Maximum Ratings

Output power ratings refer to the SM fiber output. The operating temperature of the submount is identical to the case temperature.

Parameter	Symbol	Values	Unit
<b>Module</b>			
Operating temperature range at case	$T_C$	- 40 ... + 85	°C
Storage temperature range	$T_{stg}$	- 40 ... + 85	°C
Soldering temperature $t_{max} = 10$ s, 2 mm distance from bottom edge of case	$T_S$	260	°C

## Maximum Ratings (cont'd)

Parameter	Symbol	Values	Unit
<b>Laser Diode</b>			
Direct forward current	$I_{F \max}$	120	mA
Radiant power CW	$\Phi_e$	1	mW
Reverse Voltage	$V_{R \max}$	2	V
<b>Monitor Diode</b>			
Reverse Voltage	$V_{R \max}$	10	V

## Characteristics

All optical data refer to an optimally coupled 10/125  $\mu\text{m}$  SM fiber.

Parameter	Symbol	Values	Unit
<b>Laser Diode</b>			
Optical output power	$\Phi_e$	> 0.4	mW
Emission wavelength center of range $\Phi_e = 0.2 \text{ mW}$	$\lambda$	1280 ... 1330	nm
Spectral bandwidth $\Phi_e = 0.2 \text{ mW}$ (RMS)	$\Delta\lambda$	< 5	nm
Threshold current	$I_{\text{th}}$	2 ... 45	mA
Forward voltage $\Phi_e = 0.2 \text{ mW}$	$V_F$	< 1.5	V
Radiant power at threshold	$\Phi_{\text{eth}}$	< 10	$\mu\text{W}$
Slope efficiency	$\eta$	8 ... 60	mW/A
Differential series resistance	$r_S$	< 8	$\Omega$
Rise time/fall time	$t_r, t_f$	< 1	ns
<b>Monitor Diode</b>			
Dark current, $V_R = 5 \text{ V}$ , $\Phi_e = 0$	$I_R$	< 500	nA
Photocurrent, $\Phi_e = 0.2 \text{ mW}$	$I_P$	100 ... 1000	$\mu\text{A}$

**Laser Diode**  
Radiant Power in Singlemode Fiber

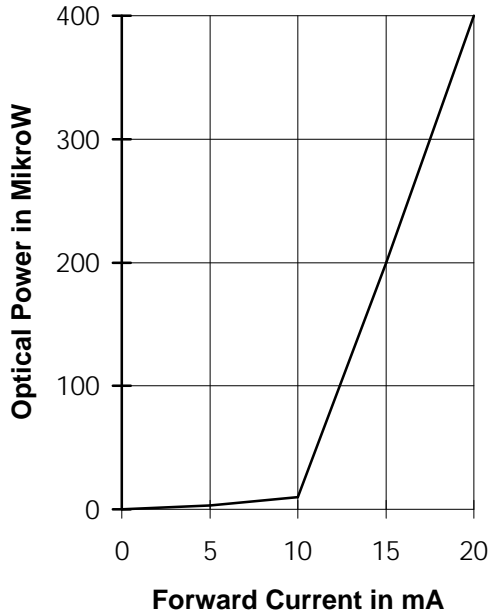

**Relative Radiant Power**  
 $\Phi_e = f(\lambda)$

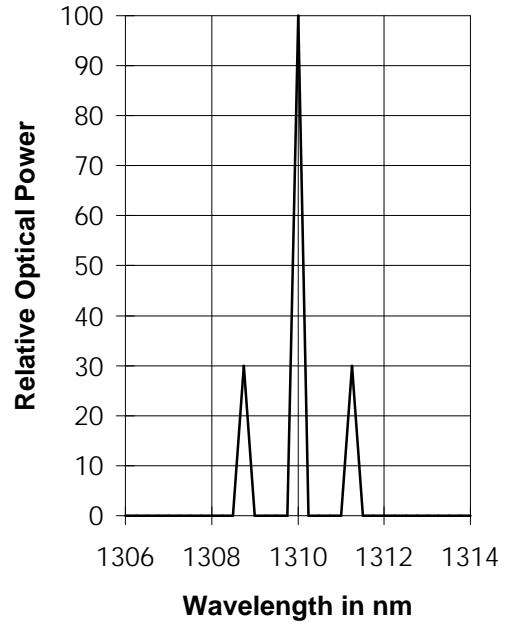

**Laser Forward Current**  
 $I_F = f(V_F)$

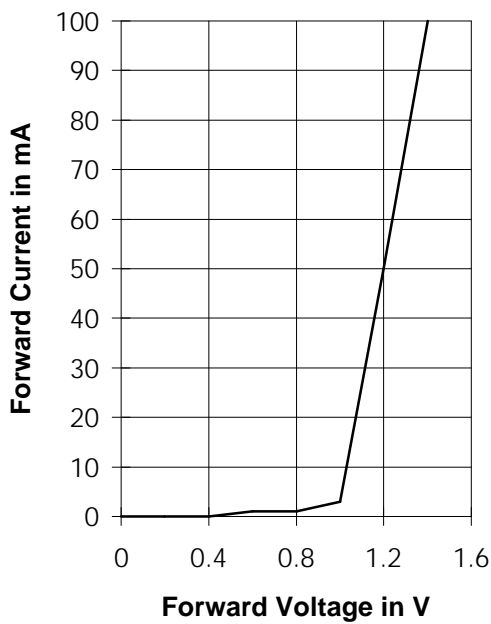

**Monitor Diode Dark Current  $I_R = f(T_A)$**   
 $\Phi_{port} = 0, V_R = 5 V$

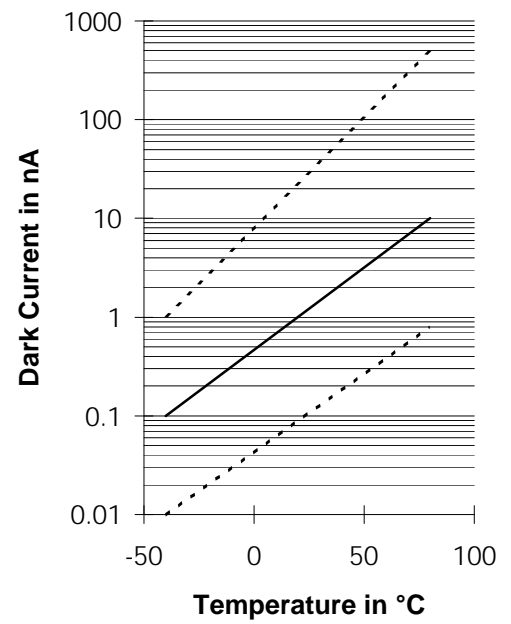

Package Outlines (Dimensions in mm)

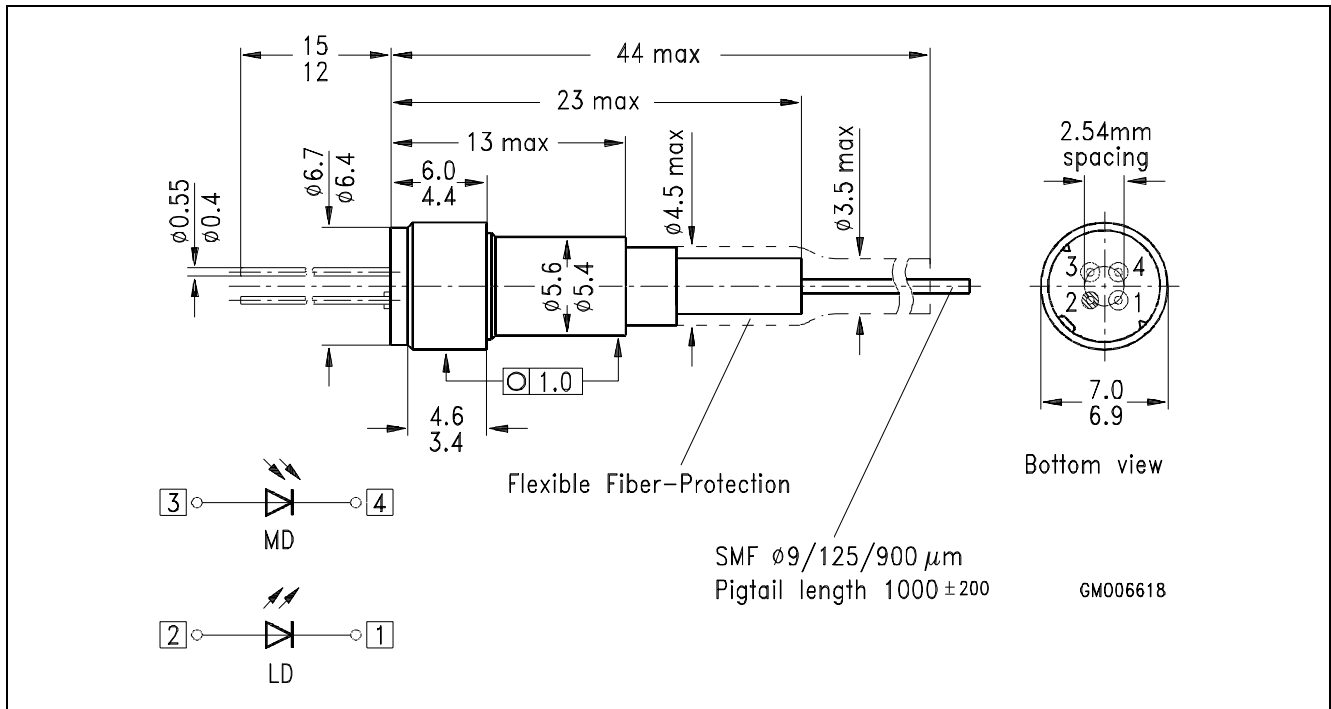

STL 51004X

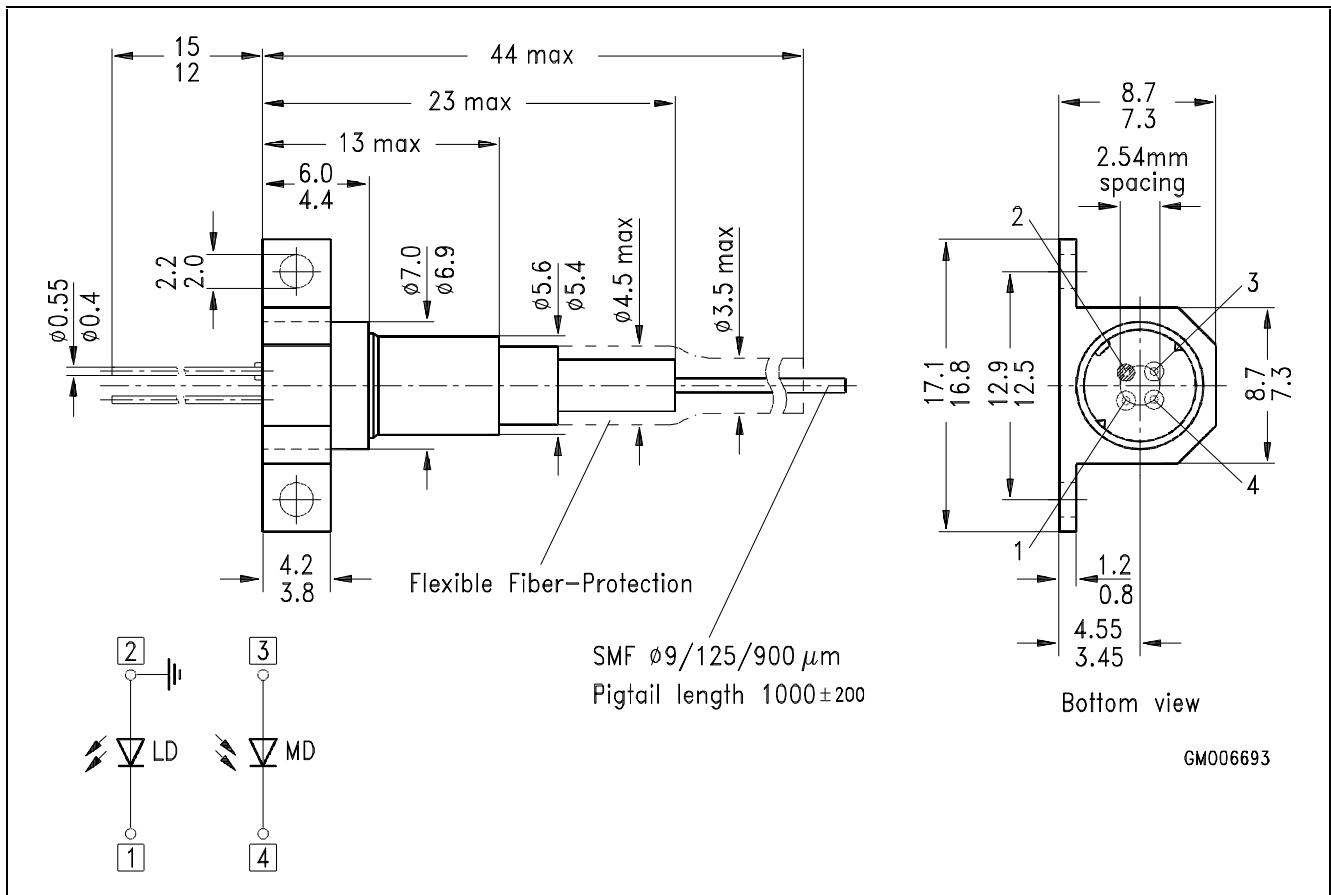

STL 51005X (with flange)